

## Accessori Accessories

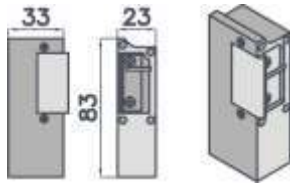

### Incontri Elettrici Electric Strikers



Code Codice	Finitura Finishing	Mano Hand	Confenzione Packaging
I/E 125 DX	CR	DX	10
I/E 125 SX	CR	SX	10

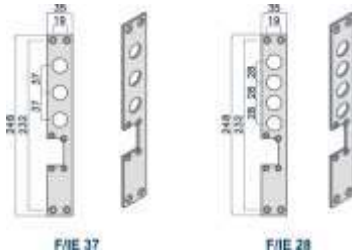

### Frontali per Incontri Elettrici Plates for Electric Strikers

Code Codice	Finitura Finishing	Mano Hand	Confenzione Packaging
F/IE 28 DX	CR	DX	10
F/IE 28 SX	CR	SX	10
F/IE 37DX	CR	DX	10
F/IE 37SX	CR	SX	10

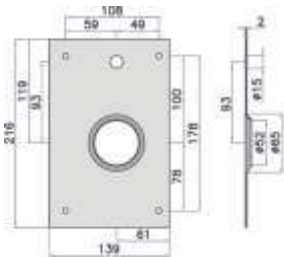

**PIAM2**

### Piastre di fissaggio Fixing plate for lock

Code Codice	Per Articolo For Article	Mano Hand	Materiale Material
PIAL3	501**	DX-SX	Acciao-Steel 3mm
PIAL3/IM/D	501**	DX	Acciao-Steel 3mm
PIAL3/IM/S	501**	SX	Acciao-Steel 3mm
PIAL32	502**	DX-SX	Acciao-Steel 3mm
PIAL32/IM/D	502**	DX	Acciao-Steel 3mm
PIAL32/IM/S	502**	SX	Acciao-Steel 3mm

Code Codice	Per Articolo For Article	Mano Hand	Materiale Material
PIAM2	501**	DX-SX	Manganese-2mm
PIAM2/IM/D	501**	DX	Manganese-2mm
PIAM2/IM/S	501**	SX	Manganese-2mm
PIAM22	502**	DX-SX	Manganese-2mm
PIAM22/IM/D	502**	DX	Manganese-2mm
PIAM22/IM/S	502**	SX	Manganese-2mm

## Cilindro a Profilo Europeo C-MAX European Profile Cylinder C-MAX

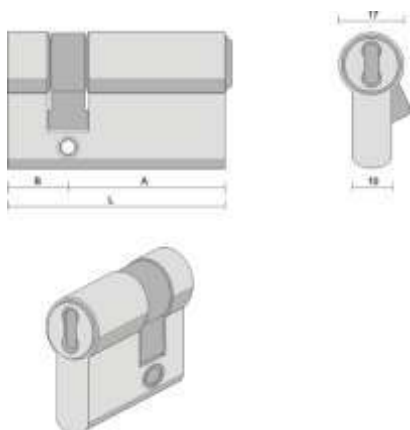

Code Codice	A	B	L
C-MAX 0/36	27	9	36
C-MAX 0/41	32	9	41
C-MAX 0/46	37	9	45
C-MAX 0/31	42	9	51
C-MAX 0/36	47	9	56
C-MAX 0/41	52	9	61
C-MAX 0/36	57	9	66
C-MAX 0/46	62	9	71
C-MAX 0/41	67	9	76
C-MAX 0/51	72	9	81
C-MAX 0/46	77	9	86

## Cilindro a Profilo Europeo C-MAX European Profile Cylinder C-MAX

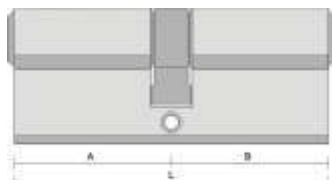

Codice Code	A	B	L
C-MAX 27/36	27	36	63
C-MAX 27/41	27	41	68
C-MAX 27/46	27	46	73
C-MAX 27/31	31	31	62
C-MAX 27/36	31	36	67
C-MAX 27/41	31	41	72
C-MAX 36/36	36	36	72
C-MAX 31/46	31	46	77
C-MAX 36/41	36	41	77
C-MAX 31/51	31	51	82
C-MAX 36/46	36	46	82
C-MAX 41/41	41	41	82
C-MAX 31/56	31	56	87
C-MAX 36/51	36	51	87
C-MAX 41/46	41	46	87
C-MAX 31/61	31	61	92
C-MAX 36/56	36	56	92
C-MAX 41/51	41	51	92
C-MAX 46/46	46	46	92
C-MAX 31/66	31	66	97
C-MAX 36/61	36	61	97
C-MAX 41/56	41	56	97
C-MAX 46/51	46	51	97
C-MAX 31/71	31	71	102
C-MAX 36/66	36	66	102
C-MAX 41/61	41	61	102
C-MAX 46/56	46	56	102
C-MAX 51/51	51	51	102
C-MAX 31/76	31	76	107
C-MAX 46/61	46	61	107
C-MAX 51/61	51	61	112
C-MAX 56/56	56	56	112
C-MAX 61/61	61	61	112



## Cilindro a Profilo Europeo C-MAX European Profile Cylinder C-MAX

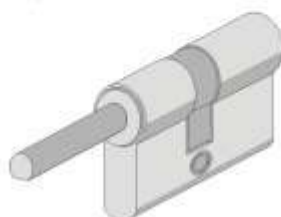
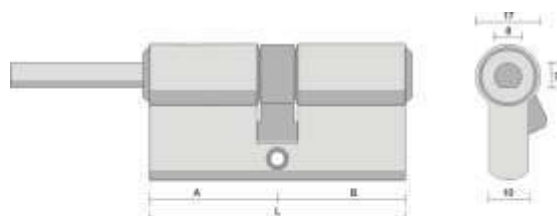

Codice Code	A	B	L
C-MAX K/31	31	31	62
C-MAX K/36	31	36	67
C-MAX K/41	31	41	72